

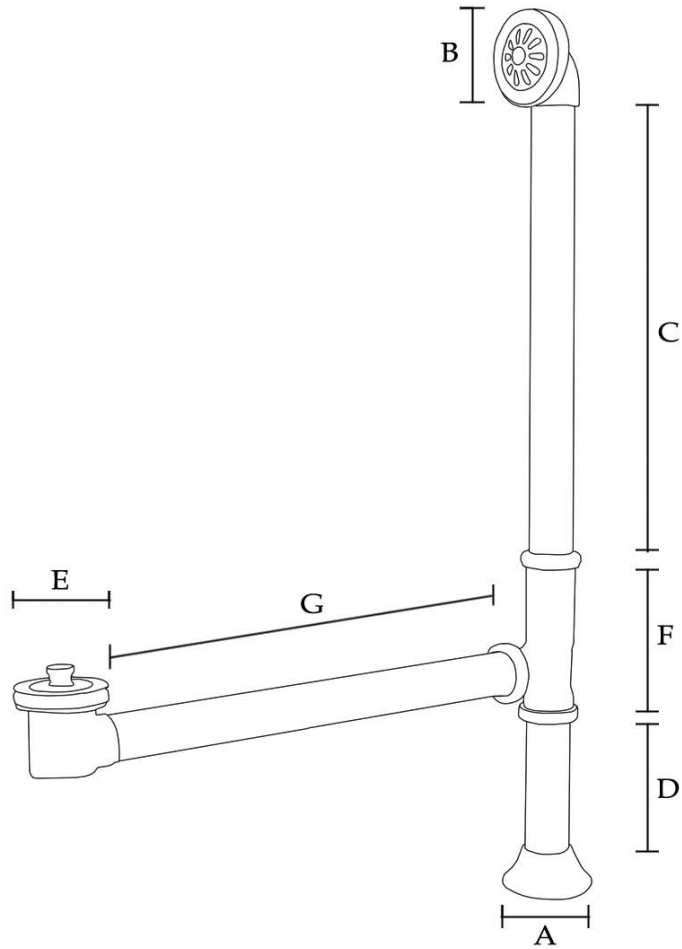

Extended Lift & Turn Tub Drain by Randolph Morris

Item #: RM1900LTB



(A) Flange: 3" OD	(D) Short Tube: 6" L	(G) Waste Tube: 18-3/4" L
(B) Overflow Plate: 3" OD	(E) Strainer: 2-3/4" OD	
(C) Overflow Tube: 18-3/4" L	(F) "T": 5-1/2" L	Designed to fit new clawfoot tubs

All products and specifications are subject to change without notice. Randolph Morris is not responsible for typographical and/or dimensional errors. Typographical errors are subject to correction.

Note: Rough-in dimensions may vary +/- 1/2" and are subject to change. No responsibility is assumed by Randolph Morris.